

DOT PEEN MARKING MACHINE

e10 i53



+ ULTRA COMPACT

- Easy integration: 4 mounting areas
- Marking window: 50 x 20 mm

+ POWERFUL

- Precise and accurate guides
- Marking speed and quality
- Marking on all types of materials and difficult surface conditions
- Marking of standard 2D codes (Data Matrix)
- Tolerance to stylus / part distance variation
- 100% electromagnetic

+ ROBUST AND RELIABLE

- Leather protective bellows
- Reduced maintenance
- Design for intensive use in industrial environments



APPLICATIONS

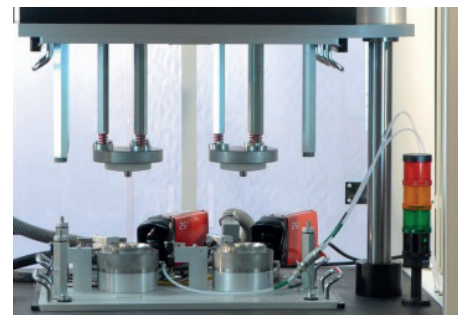
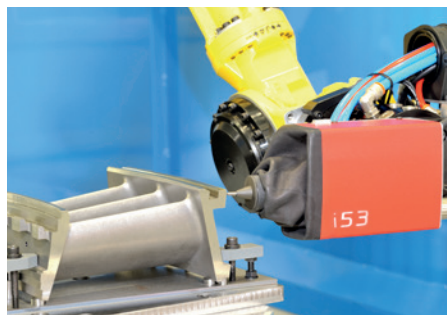
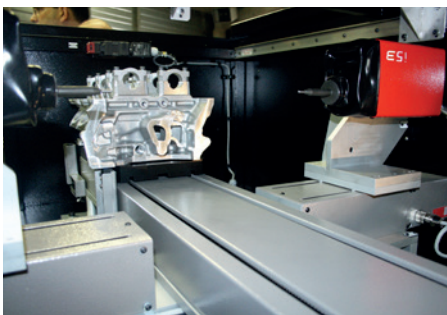

DOT PEEN MARKING EXAMPLES

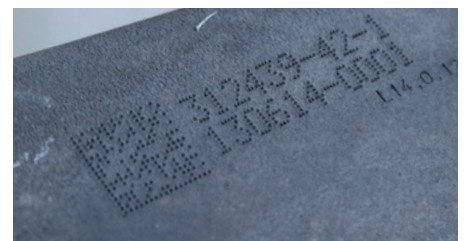

TECHNICAL & MECHANICAL FEATURES

e10 i53	
Marking window	50 x 20 mm - 2 x 0.8 in
External dimensions	250 x 130 x 70 mm - 9.8 x 5.1 x 2.7 in
Weight	2,6 kg - 4.4 lbs
Stylus	Tungsten carbide 60 mm - 2.4 in (80 mm - 3.1 in optional)
Machine / controller cable length	5 m - 16.4 ft (10 or 15 m - 32.8 or 49.2 ft optional)
Protective Bellows	Leather

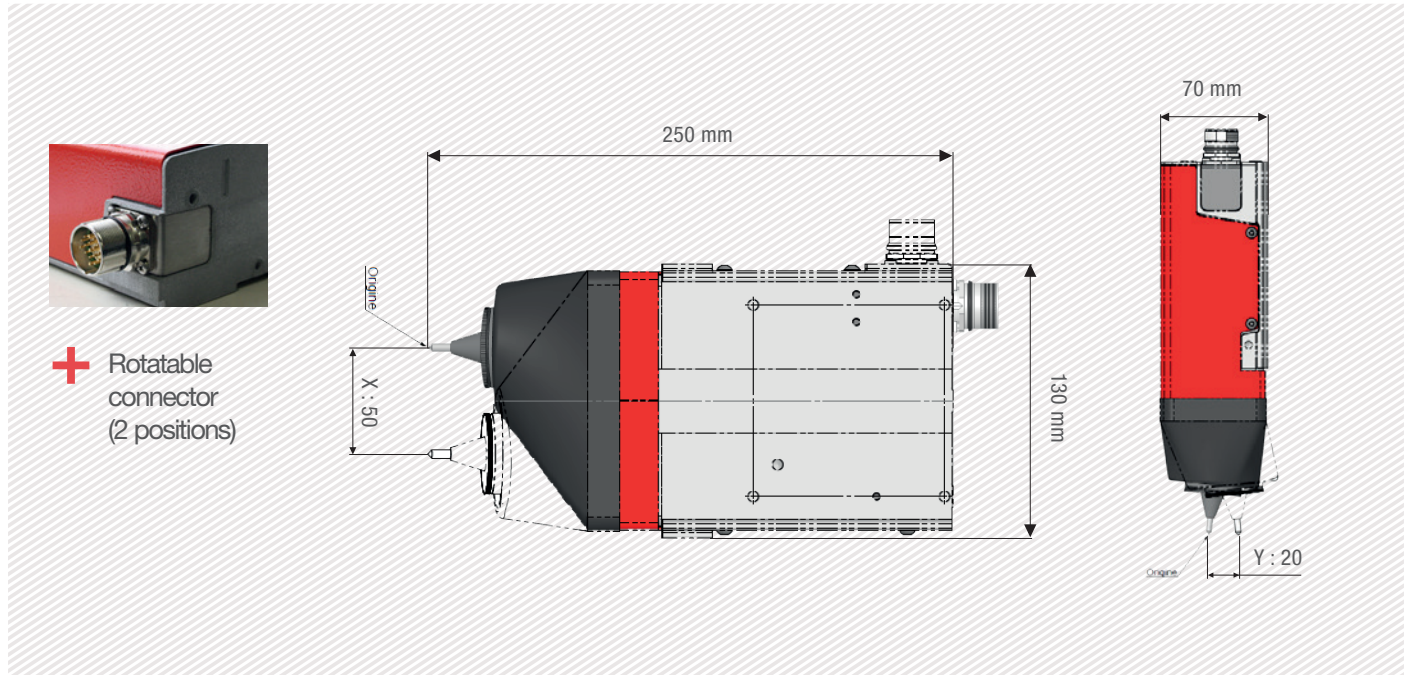

OPTIONS

 <p>Z axis 50 to 250 mm</p>	 <p>DIN rail kit for e10R controller</p>	 <p>Wide range of stylus</p>	 <p>Start & Stop Button Box</p>	 <p>PC software</p>
 <p>Datamatrix reader</p>	 <p>Wireless barcode reader</p>	 <p>Maintenance kit</p>	<p>Please consult us if a specific configuration is not published in the table attached.</p> <p>SIC Marking designs customized and turnkey solutions for all industrial sectors. Our design offices produce machines in compliance with your specifications and your industrial standards.</p>	

E10 CONTROL UNIT



The e10 controller

- Color screen
- USB Port: to easily upload / download your marking files
- Fully programmable
- Standalone (no PC needed)
- Membrane protected industrial Keyboard
- IP40 waterproof box (no opening or fan)



- + Color screen
- + USB Port
- + Multiple connectivities
- + PC software and utilities

Technical & electronic features

e10 Controller		Communication	
Dimensions	322 x 380 x 112 mm - 13.7 x 15 x 4.4 in	Communication ports	RS232, RS422, USB, RS485 Profibus, TCP/IP, Ethernet/IP
Weight	5 kg - 11lbs	Inputs-outputs	8/8
LCD screen resolution	480 x 272 pixels	External keyboard input	USB
Keyboard	Qwerty integrated, protected by membrane	PC software	Creation of marking files, transfer controller / PC or USB key
Power	300 Watt	Optional communication cards:	
Power supply	Single phase, 85 to 260 VAC, 50 to 60 Hz	Ethernet TCP	
Controlled axes	2 (optional 3rd / 4th axis card)		 
Operating temperature	From 5 to 40°C		

PC UTILITIES

File editor

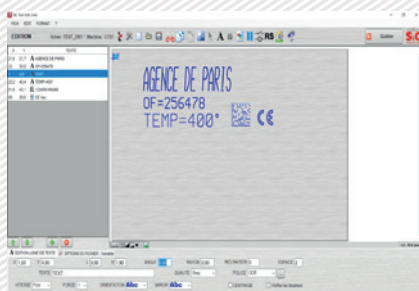

- + Creation or modification of files on PC.

Creation of logos



- + Creation of vector and matrix logos.

Creation of logos

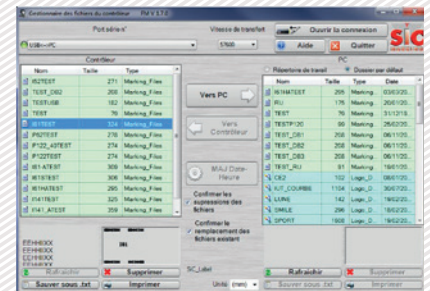

- + Backup and file transfer utility.

E 10 RANGE SOFTWARE

Software features

Text function	Incrementation, date codes
Logos	Download from a PC or USB key
Datamatrix	Up to 348 characters, 48 x 48 dots
Fonts	Arial, Comic, Comic_B, Courier, OCR, OCR_BOLD, OCRA, 4x6
Style	Angular, Radial, Inverse, and Mirror
Character Size	From 0,1 mm to 99 mm (limited following marking window)
Depth	Up to 0,3 mm (according to the material)
Resolution Between Dots	0,05 mm MAX
Password	2 security levels
History function	Exportable Excel file
Help with maintenance	Auto diagnosis
Available languages	17



Graphic view



Edit menu

AFFECTATION DES I/O		
Num	Entrée	Sortie
1	ARRET	Cycle
2	DEPART	Dernier
3	Sel. Fich	Erreur
4	Sel. Fich	Pause
5	Sel. Fich	Prêt
6	Sel. Fich	PasPièce
7	Sel. Fich	Pièce
8	Sel. Fich	Usure

STATISTIQUES CONTROLEUR		
Déplacements	Mémoire	
0 Cycles	33 Fichiers	
0 Caractères	17959 o. Utili.	
AXE X 0.0 m	46409 o. Libres	
AXE Y 0.0 m	27% Utilisées	
AXE Z Num. 0.0 m		
Impacts		
F1: 0	F4: 0	F7: 0
F2: 0	F5: 0	F8: 0
F3: 0	F6: 0	F9: 0

PC software for directly controlling the marking machine.

Available functions:

- Editing of marking files
- Input / output management
- History function and anti duplicates
- Datamatrix ECC200 and UID
- ...

OPTIONAL WINSIC SOFTWARE

WINSIC is a PC software for direct control of the marking machine.

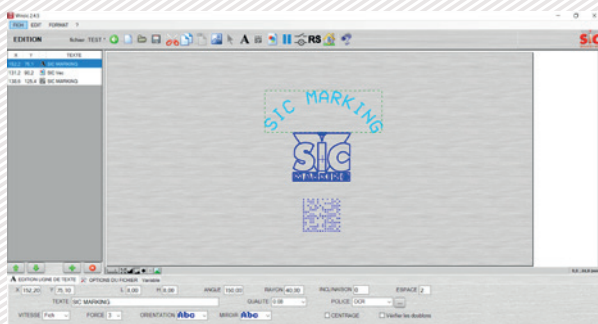

+ Built-in logo design utility

+ Database Management (Excel, Access, txt)



+ Insertion of background images

